



SONING

BUDOWA MASZYN

AUTOMATYKA PRZEMYSŁOWA

ROBOTYZACJA LINII PRZEMYSŁOWYCH

OBLICZENIA WYTRZYMAŁOŚCIOWE

SCHEMATY ELEKTRYCZNE

SYMULACJE PROCESÓW

MONTAŻ MECHANICZNY I ELEKTRYCZNY

PREFABRYKACJA SZAF STEROWNICZYCH

PLANOWANIE LINII PRODUKCYJNYCH I PROTOTYPOWANIE 3D

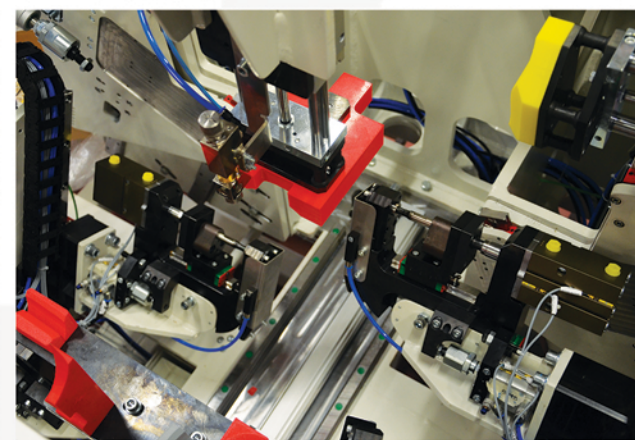
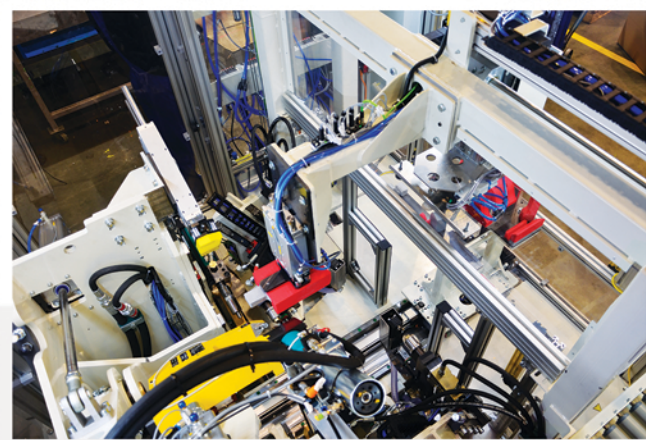
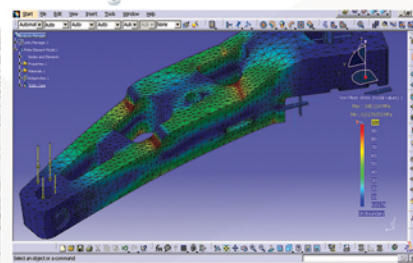
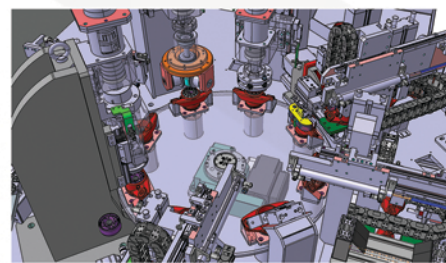
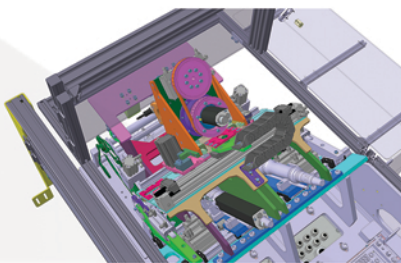
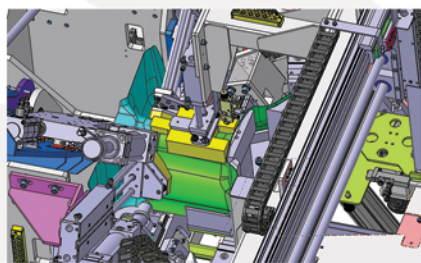
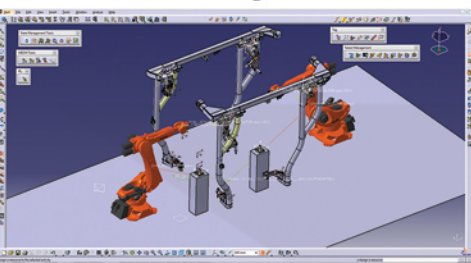
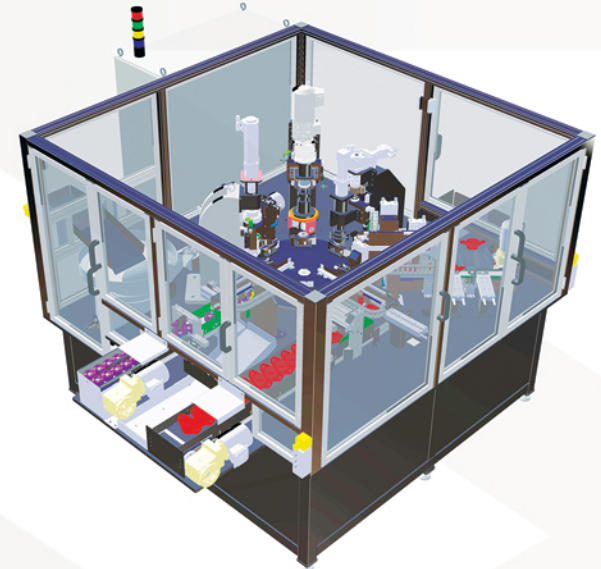
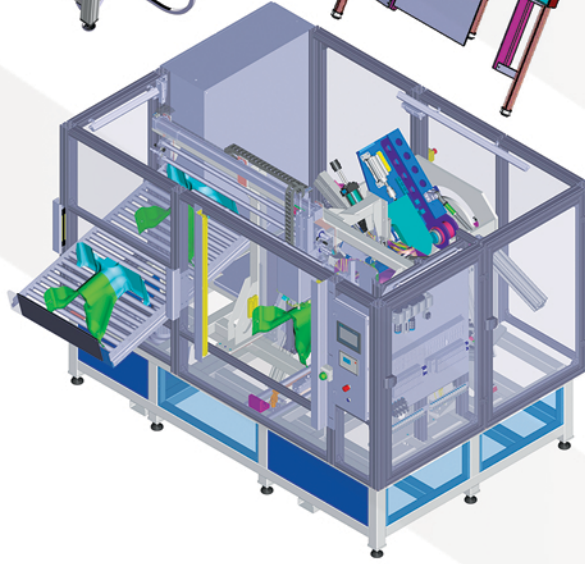
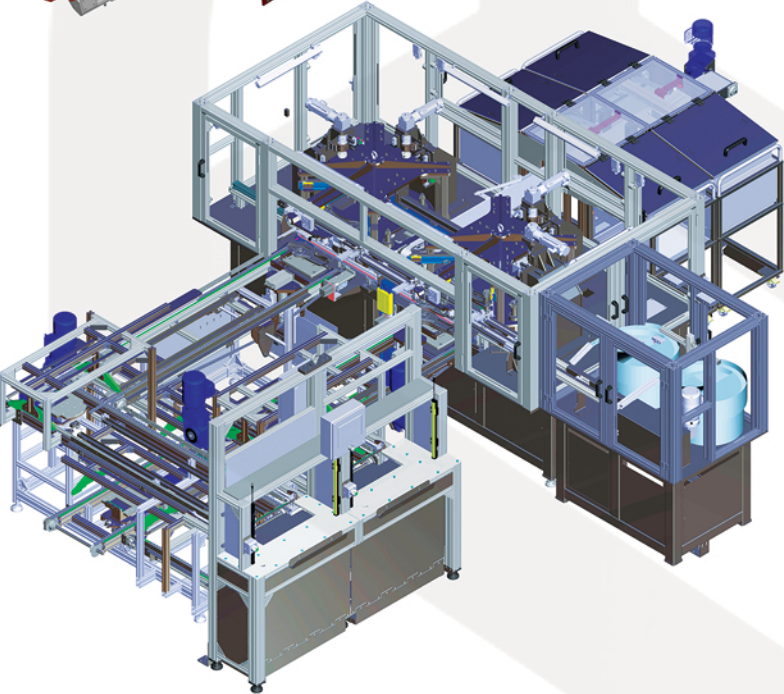
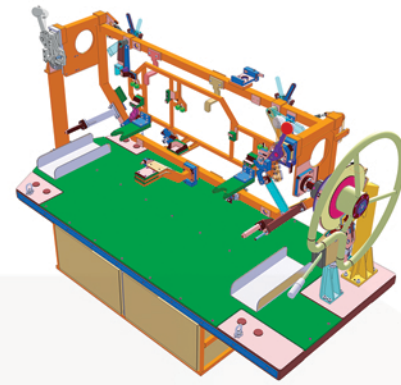
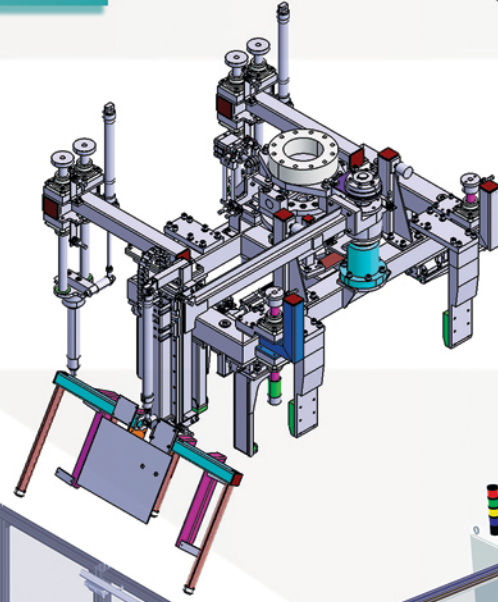
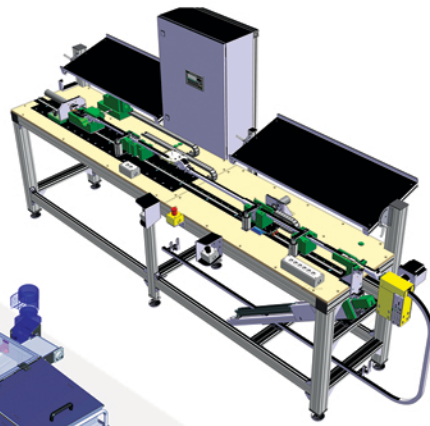
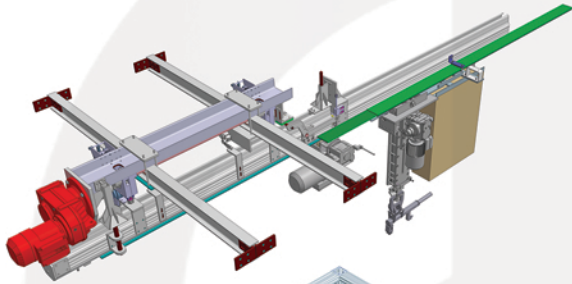
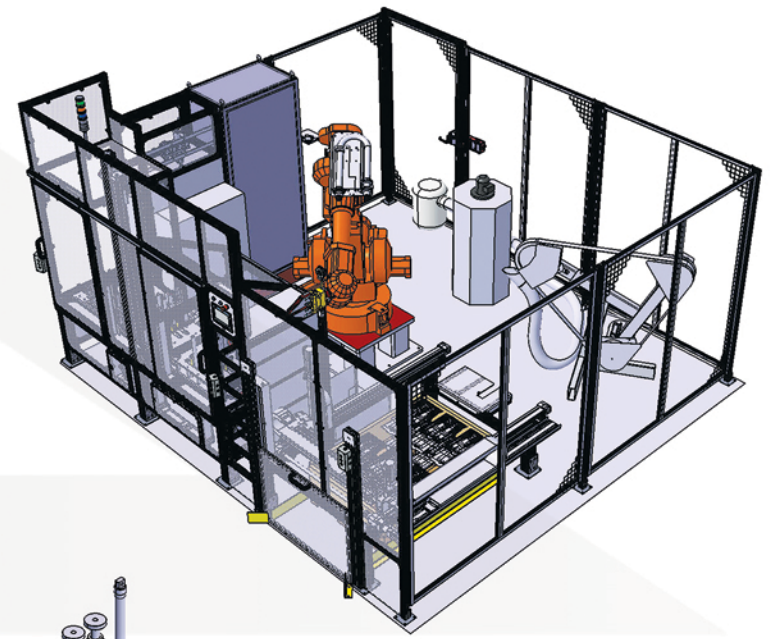

SIEMENS STEP 7 MANAGER

UNITY PRO XL



CATIA

ePLAN electric 8

ABB

RobotStudio™

InduSoft



ENOVIA

SIEMENS

TIA Portal